

Centre for the
Fourth Industrial
Revolution

WORLD
ECONOMIC
FORUM

Impact report January 2024

Centre for the Fourth Industrial Revolution Network 2022-2023



Contents

Preface	03
The Centre for the Fourth Industrial Revolution Network	04
1 Shaping responsible AI policies	07
2 Safeguarding food systems	11
3 Accelerating smart manufacturing	14
4 Building healthy and inclusive societies	16
5 Supporting small businesses	20
6 Protecting the environment	22
7 Educating and upskilling populations	24
8 Fostering partnerships and communities	25
Meet the Fourth Industrial Revolution Centres	29
Contributors	38
Endnotes	43

 Use the magnifying glass found within the text to navigate to a specific case study.

Image source: Getty Images

Preface

In just six years, the Centre for the Fourth Industrial Revolution Network grew to 19 centres across five continents, with measurable impact at local and global levels.

In a dynamic and complex world, technology is a powerful force that drives progress, transformation and innovation. Recognizing this, the World Economic Forum opened its first Centre for the Fourth Industrial Revolution in San Francisco in 2017, shortly followed by centres in Japan and India, forming the start of a much-needed global network to better understand and shape technological change.

As the network grew to 19 centres spread across five continents, so did measurable progress towards the Centre for the Fourth Industrial Revolution's mission of helping stakeholders harness the full potential of technological progress for the equitable and human-centred transformation of industries, economies and societies. It is within this context that the first Annual Impact Report of the Centre for the Fourth Industrial Revolution Network is presented, celebrating the accomplishments of centres in the network from Q4 2022 to Q3 2023.

From boosting food production in Colombia to protecting health data in Serbia, accelerating "smart" manufacturing in Saudi Arabia to shaping artificial intelligence (AI) policy in Rwanda, it is clear that the Centre for the Fourth Industrial Revolution Network's commitment to responsible technology adoption is having a profound and positive impact on the world. The stories within this report are just a glimpse of what is possible when the global community comes together to harness the power of technology for the greater good.

This journey continues into the year ahead, where strengthened collaboration with existing centres and expansion into new regions will deliver even more impact. Harnessing the Fourth Industrial Revolution to address pressing challenges and seize its incredible opportunities is a collective effort. Thank you to all who have joined in this transformative journey.

The Centre for the Fourth Industrial Revolution Network

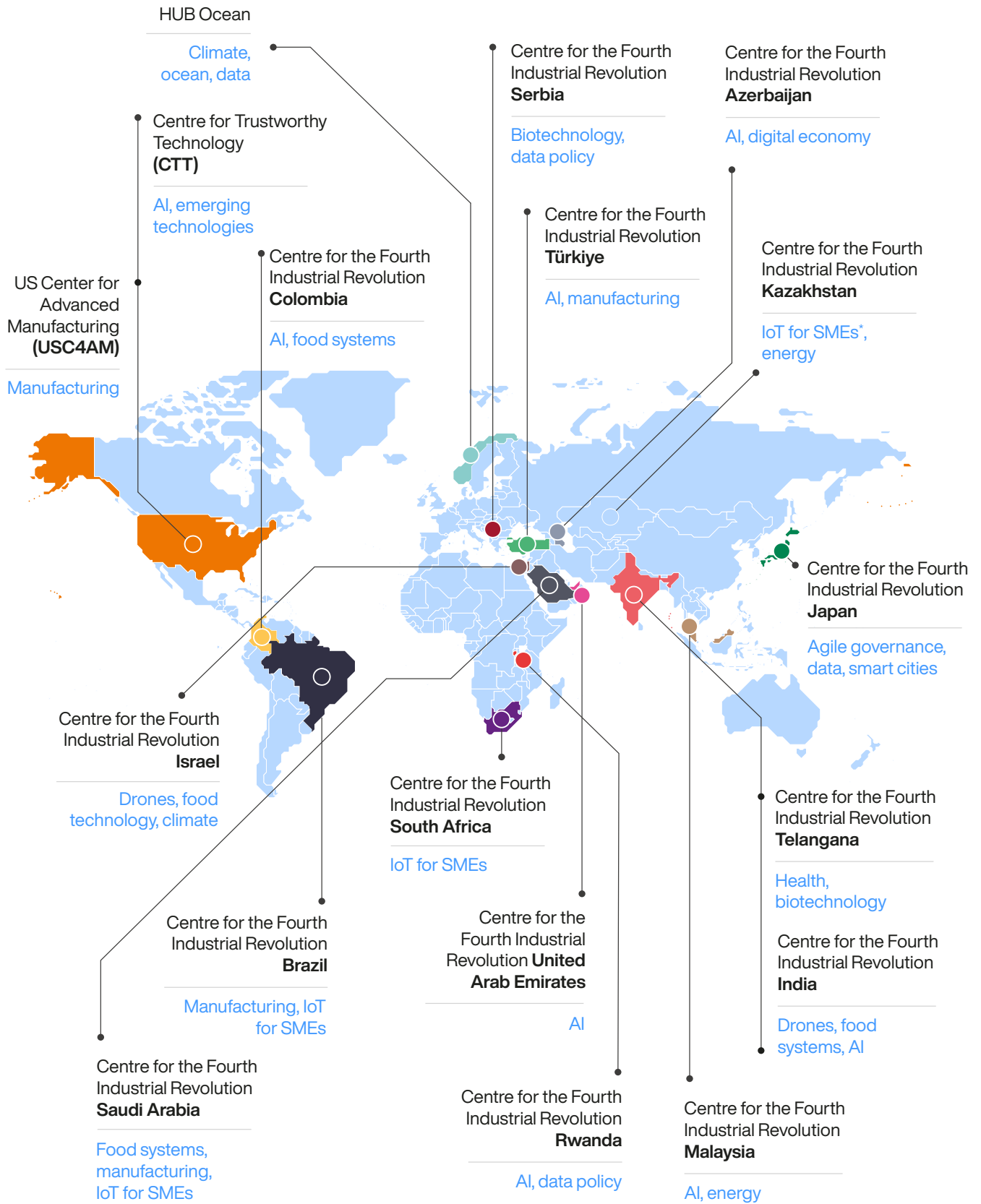

*Small- and medium-sized enterprises

2023: A year of impact

The Centre for the Fourth Industrial Revolution Network accelerates the responsible adoption of technology and transformation of industry at the national, subnational and global levels via policy-making, pilots and partnerships.

Centres advance this mission by tapping into the World Economic Forum's communities, initiatives, convening power, infrastructure and visibility.

100+

initiatives



9,000+

participants



40+

technology pilots



400+

partners and collaborators



70+

events hosted



2,500+

media mentions



170+

speaking engagements



2.5 million

digital audience



Interested in leading the regional and global technology agenda and improving the state of the world through public-private partnerships?

Contact us: C4IRnetwork@weforum.org

Timeline of centres joining the network

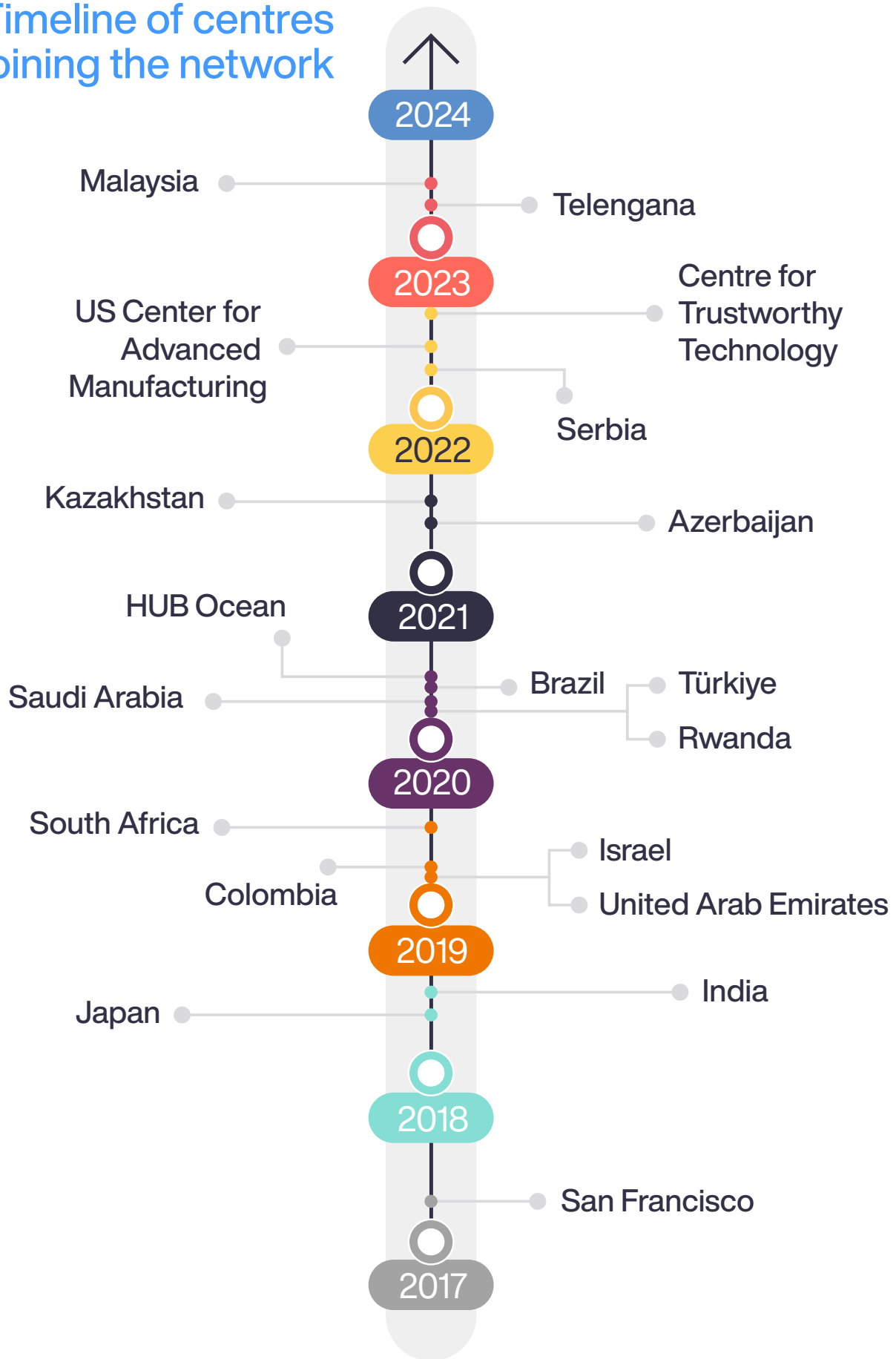

01

Shaping responsible AI policies

AI has the potential to transform industries, boost economies and improve public services if business and government leaders seize the opportunities and mitigate the risks.

From economic analysis to industry guidance and policy implementation, centres across the network are helping unlock the benefits of artificial intelligence (AI).

The Centre for the Fourth Industrial Revolution Malaysia produced a report outlining the potential economic impact of implementing generative AI in the workplace as well as recommendations for decision-makers (see case study 1). The Centre for the Fourth Industrial Revolution Türkiye focused on creating actionable advice on how AI can be adopted across the manufacturing sector for greater efficiency (see case study 5).

Centres in Azerbaijan and Rwanda worked with their national governments to shape AI policies, to ensure that the benefits of AI are accessible and advantageous to all citizens (see case study 2). Meanwhile, the Centre for the Fourth Industrial Revolution Japan proposed an international cooperation framework to operationalize secure data transfer across borders, necessary for the full potential of AI to be realized. This “Data Free Flow with Trust” (DFFT) framework was endorsed by the G7 digital and technology ministers, and featured in their ministerial declaration.



Case study 1:

Malaysia – analysing the economics of generative AI on the future of work



Context:

Global reports on the potential economic impact of generative AI are not contextualized for the Malaysian workforce and economy, so it can be challenging.



Action:

The Centre for the Fourth Industrial Revolution Malaysia together with Access Partnership and Microsoft organized a roundtable discussion on the economic impact of generative AI in Malaysia and summarized the outputs in the report [The Economic Impact of Generative AI: The future of work in Malaysia](#).¹



Result:

The report estimates that using generative AI to transform the way work is currently done in the Malaysian economy can potentially unlock \$113.4 billion of productive capacity and provides a framework of 16 recommendations to drive generative AI use for consideration by government and business leaders.



Next steps:

Collaborate with industry partners to study the impact of generative AI on specific sectors such as education and agriculture.



Technology empowers us to foster innovation that embodies the essence of change. In an era marked by fierce competition and rapid development, shying away and resisting change is a hindrance to development. Instead, we need to embrace change and commit to the future of work so that we can benefit from it.

Rafizi Ramli

Minister of Economy, Malaysia²

Case study 2:

Rwanda – implementing a national AI policy



Context:

Rwanda is positioning itself as a leader in AI innovation and responsible AI applications within the African continent, ensuring all citizens benefit from this exponential technology.



Action:

The Centre for the Fourth Industrial Revolution Rwanda collaborated with the Ministry of ICT and Innovation and the German development agency, GIZ, to develop the country's national AI policy. The policy lays out a roadmap to drive economic growth, enhance public service delivery and foster inclusive and sustainable development in the country.



Result:

By integrating international insights from the network with the country's unique needs, the Rwanda centre was instrumental in ensuring the AI policy was tailored to the country's socioeconomic context, underpinned by global standards and informed by diverse stakeholders.



Next steps:

Among its responsibilities laid out in the policy, the Centre for the Fourth Industrial Revolution Rwanda will have several roles that will help shape the AI landscape in the country. This will include establishing a public-private task force

to develop protocols for data sharing across industries, developing an annual AI Readiness Index and Maturity Assessment Framework to benchmark Rwanda's AI progression and developing sector-specific industry AI deployment plans, providing step-by-step guides on AI digital solutions to adopt at each stage of a company's growth.



The policy represents a significant milestone in the launch and development of Rwanda's AI ecosystem and is a critical step towards achieving our national development goals. We are positioning ourselves to become the leading destination in Africa for experimenting with and developing trustworthy AI technologies contextualized for the African continent.

Paula Ingabire
Minister of ICT and Innovation, Rwanda³



The network of national and subnational Centres for the Fourth Industrial Revolution, curated by the World Economic Forum, provides a platform for over 16 countries to work together in shaping technological developments, such as AI and quantum computing, for the benefit of global society.

Klaus Schwab

Founder and Executive Chairman, World Economic Forum



02 | Safeguarding food systems

From water scarcity to supply chain disruption, food systems will need to overcome a number of challenges in the coming decades, and technology can help by supporting farmers' livelihoods and ensuring people don't go hungry.

The Centre for the Fourth Industrial Revolution India launched the country's first agriculture data exchange platform where farmers, scientists, government representatives and business owners can access agricultural data on pests, weather patterns and market prices to improve agricultural practices. The centre also piloted its AI for Agriculture Innovation (AI4AI) initiative with 7,000 farmers, raising profits by 18% per acre of land [\(see case study 3\)](#).

The Centre for the Fourth Industrial Revolution Colombia took the best practices from India's AI4AI project and modified it for the Colombian context, focusing on avocado, cacao and coffee farming [\(see case study 4\)](#).

In September 2023, the Centre for the Industrial Revolution Israel led a delegation of Israeli food technology start-ups in Switzerland to fortify partnerships, foster innovation and contribute to global efforts to enhance food security, combat climate change and fuel economic growth. The start-ups – which span alternative proteins, sugar reduction and AI for food manufacturing – met with key international stakeholders in Geneva and at the World Economic Forum headquarters.



7,000

farmers

were involved in the center's pilot of its AI for Agriculture Innovation (AI4AI) initiative, which led to an **18% increase in profits per acre of land.**

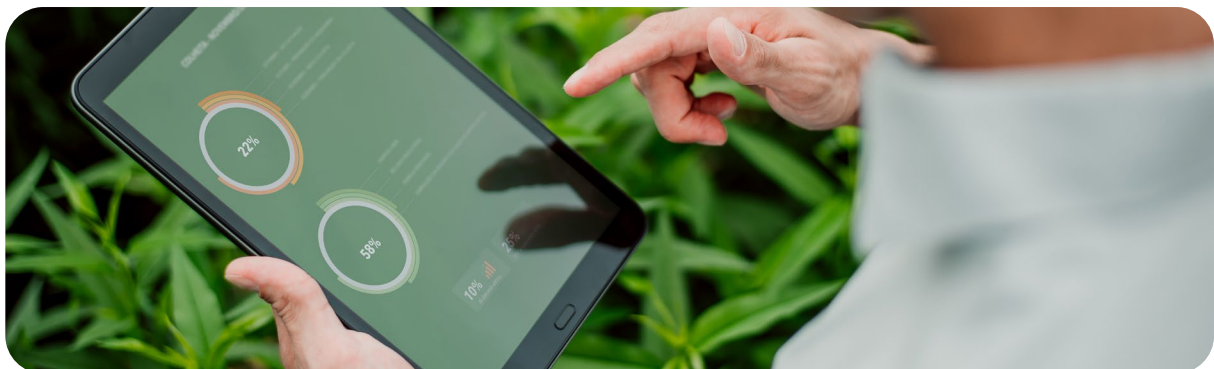

Case study 3:

India – increasing chilli yields with digital technologies



Context:

India is faced with the challenge of feeding a growing population while also addressing risks such as climate change and supply chain disruptions.



Action:

The India centre partnered with the state of Telangana to pilot their AI4AI initiative with 7,000 chilli farmers to encourage the use of digital technologies in farming processes, from intelligent crop planning to soil and weather analysis and supply chain optimization.



Result:

18%

incremental profits per acre were achieved by participating farmers

21%

crop yield increase

9%

reduction in pesticide use



Next steps:

The centre plans to scale the pilot beyond the chilli value chain to five crops, across 10 districts, reaching 500,000 farmers. The centre is also actively supporting the implementation of AI4AI across the network in Saudi Arabia, Brazil, Colombia and South Africa.

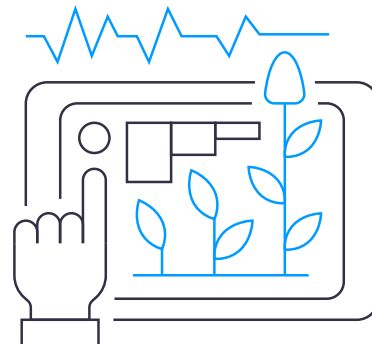

The digital agriculture initiative AI4AI is the first of its kind in the country that is leveraging Fourth Industrial Revolution technologies for transforming the lives of smallholding and women farmers.

Rama Devi

Director, Emerging Technologies, Telangana Government⁴

Case study 4:

Colombia – revolutionizing avocado farming with digital tech



Context:

The UN identified Colombia as one of the five countries that could help avoid global food shortage in 2030 if their agricultural potential were realized.



Action:

Taking best practices from the AI4AI project in India, the Centre for the Fourth Industrial Revolution Colombia, together with the Colombian Ministry of ICT, ran a pilot project to boost the adoption of digital technologies in coffee, cacao and avocado farms across 10 municipalities, involving 700 farmers. Farms were equipped with climate and soil sensors and managed through the use of satellite intelligence and drone surveillance. Furthermore, an e-commerce platform was employed to assist farmers in selling their produce.



Results:

35%

savings on fertilizers were realized by participating farmers, who also produced 30% more yield and sold all their produce via the e-commerce platform. The results informed recommendations for public policy that were presented to the Ministry of ICT.



Next steps:

Discussions are under way with the ministry regarding the second phase of the project, which aims to extend its reach to 4,000 farmers and expand to additional regions of Colombia.

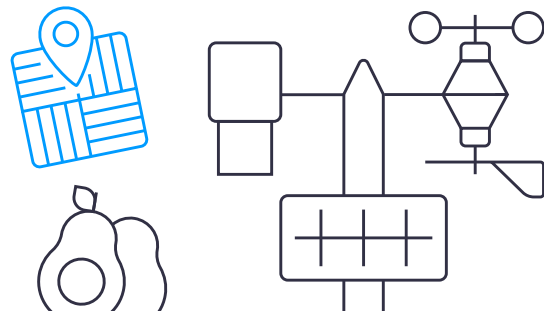

The adoption of emerging technologies is a necessity for Colombia. For this reason, the Centre for the Fourth Industrial Revolution in Colombia, which guides and advises decision-makers on how to best adopt and manage these technologies, is essential for our future.

Daniel Quintero

Former Mayor of the City of Medellin

03

Accelerating smart manufacturing

Manufacturing is the backbone of many economies worldwide. The adoption of high-performance computing, industrial robotics, 3D printing and other technologies is set to revitalize the sector and safeguard sustainable, inclusive growth.

The US Center for Advanced Manufacturing (USC4AM) – the first thematic centre in the network to focus on manufacturing – has been spearheading multiple initiatives to accelerate the digital transformation of manufacturing in the US and beyond. Through its C-Suite Strategy Series, the centre has built a cross-industry community of executives from companies that rely on manufacturing. In the reporting period, the centre convened the community around the topics of sustainability and value chains, increasing dialogue among leaders on how they can drive lasting impact.

The Centre for the Fourth Industrial Revolution Türkiye took a different approach and zoomed in on the potential of AI to revolutionize the manufacturing sector. Through the publication of a white paper, the centre created actionable advice to promote the widespread adoption of AI in manufacturing [🔗](#) (see case study 5).

Recognizing that 99% of Brazil’s manufacturing industry is comprised of small and medium-sized enterprises (SMEs), the Centre for the Fourth Industrial Revolution Brazil was able to support small business and digitalize the manufacturing sector by piloting a policy protocol to demonstrate the return on investment of adopting digital technologies [🔗](#) (see case study 8).



The International Trade Administration’s strategic partnership with the US Center for Advanced Manufacturing is important to raise awareness of the benefits of trade and investment to the US economy and to help grow and strengthen our domestic advanced manufacturing exporter base. Their collaborative ecosystem and data-driven insights are key to informing strategies and decision-making in advanced manufacturing that will keep US firms on the cutting edge of innovation.

Grant Harris

Assistant Secretary of Commerce for Industry and Analysis

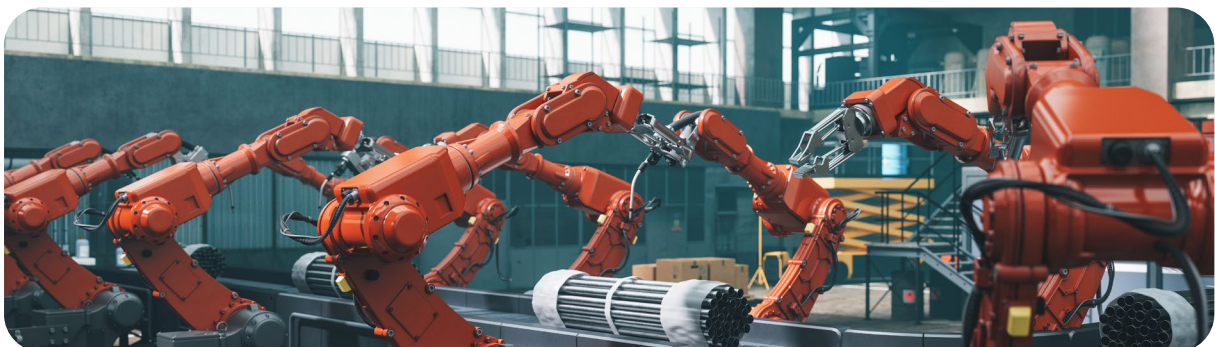

Case study 5:

Türkiye – supporting the rollout of AI in manufacturing



Context: While the impact of AI applications in manufacturing is recognized, the complete potential of their implementation remains untapped, primarily due to various organizational and technical obstacles.

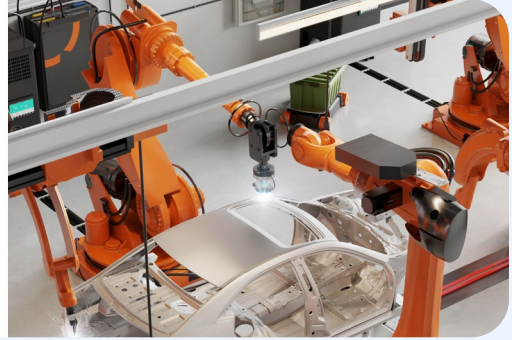

Action:

The Centre for the Fourth Industrial Revolution Türkiye convened industry, technology and academic experts to shed light on these challenges and propose a step-by-step approach to overcome them.



Result:

The 2022 white paper [Unlocking Value from Artificial Intelligence in Manufacturing⁵](#) summarizes three primary values that artificial intelligence can bring to the industry, six key challenges hindering its widespread adoption, 23 different use cases from various industries and a five-stage actionable roadmap to promote the widespread adoption of scalable AI applications in manufacturing.



Next steps:

A follow-up study looking into the current state of AI adoption in industrial operations and recent advancements in the field is being discussed in cooperation with TÜV SÜD and Boston Consulting Group (BCG). The Centre also seeks to provide a unique space for collaborations among industry leaders, technology experts and academics to deploy AI at scale in industrial operations.

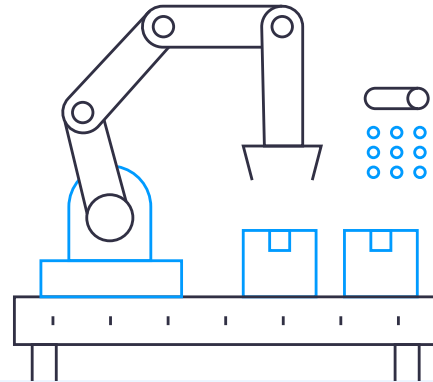

We completed more than 160 digital maturity assessments in over 10 industries, and we witnessed that industry leaders believe in creating value from AI, but they do not know how to start. Therefore we initiated the AI in Manufacturing project together with the World Economic Forum and the network of Centres for the Fourth Industrial Revolution to accelerate the use of AI in manufacturing. We would like to increase the added value generated from AI as a continuation of digital transformation. We continue to work to keep our MEXT Digital Factory at the highest technology level by developing AI-oriented use case scenarios together with technology providers.

Özgür Burak Akkol

Turkish Employers' Association of Metal Industries (MESS) Chairman⁶

04

Building healthy and inclusive societies

If deployed responsibly and equitably, emerging technologies have the potential to create healthier, more inclusive societies.

Through projects and events such as its Biotech Future Forum, the Centre for the Fourth Industrial Revolution Serbia has been creating a local and international biotechnology ecosystem. The centre was instrumental in developing legislation around the protection and privacy of genetic data of Serbian citizens [↗](#) (see case study 6).

The newly established Centre for Trustworthy Technology (CTT) in Austin, Texas, hosted a workshop on AI applications in drug discovery and development, bringing together representatives from Johnson & Johnson, Pfizer, Eli Lilly and Novo Nordisk, among other industry leaders.

The Centre for the Fourth Industrial Revolution India worked with government and hospital partners to deliver medical supplies to hard-to-reach areas in the Himalayas using drones [↗](#) (see case study 7). Meanwhile, in the neighbouring state of Telangana, the newly established Centre for the Fourth Industrial Revolution Telangana is preparing to host BioAsia in 2024, which will bring together over 2,500 participants to explore the potential opportunities that data and AI can unlock for life sciences companies and healthcare delivery overall.





Israeli disruptive innovation ecosystem presents extraordinary prowess and unique capabilities in helping humanity solve some of its existential challenges, including the climate crisis, growing congestions, limited resources to feed a growing population, as well as meeting the personalized medical need of an ageing population.

Dror Bin
Chief Executive Officer, Israel Innovation Authority

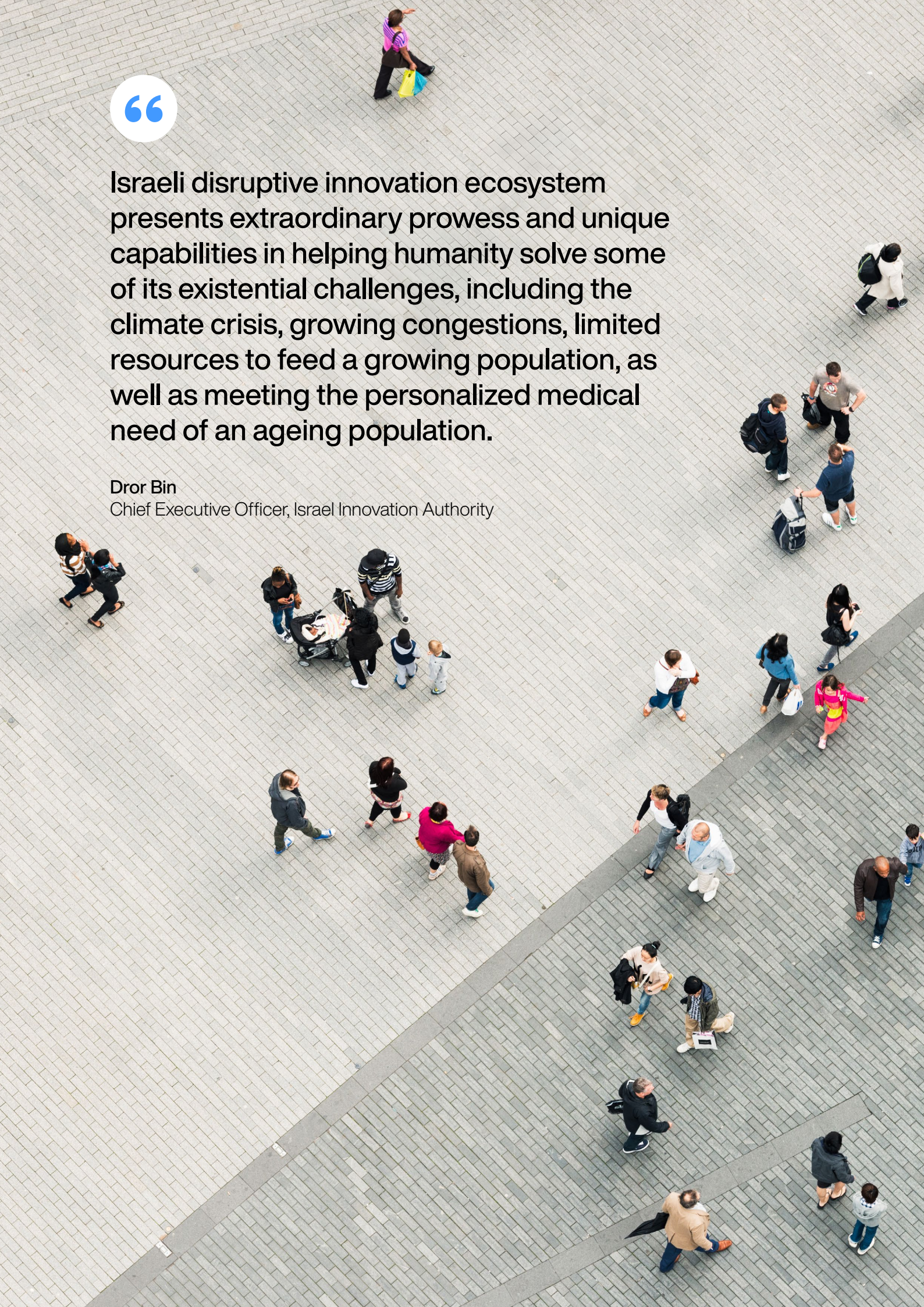

Case study 6:

Serbia – protecting citizens’ genomic and health data



Context: Serbia plans to establish a national register of genomic and health data to digitize the healthcare system and boost biomedical research. However, personal data needs to be protected.

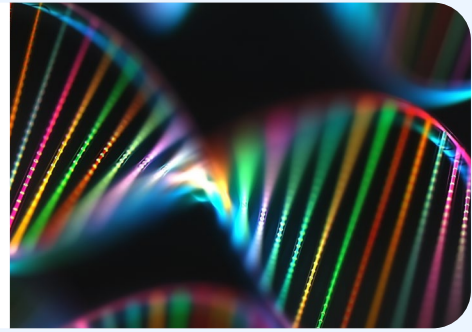

Action:

The Centre for the Fourth Industrial Revolution Serbia collaborated with the Coordination Body for the Digitalization of Health, the Ministry of Health and other stakeholders. Together, they worked to develop legislation regulating Electronic Health Records, a register of genomic data and rules ensuring the protection of citizen health and genomic data, while also allowing secondary use of data for biomedical research and innovation.



Result:

The proposed legislation was adopted by the Serbian Parliament in October 2023. The healthcare system and scientific community in Serbia are unprecedentedly united in responsible data sharing and use. Over ten institutions in Serbia now have a secure environment for storing genetic and health data. The legislation allows for an active Serbian citizen role in the healthcare system, providing access to their data and managing consent.



Next step:

With the appropriate legislation in place, the Serbia centre will coordinate the establishment of the Genetic and Biomedical Data Registry. Additionally, they will spearhead the development of bylaws that facilitate the full implementation of the law, including the establishment of an ethical board for data use, standards and data and informational security.



I am extremely pleased and honoured that Belgrade is the host of the first International Conference on the Future of Biotechnology. I hope that this is just the beginning for us, and the first step for Serbia to position itself among the leaders in the field of biotechnology in Europe.

Ana Brnabić

Prime Minister of the Republic of Serbia,
speaking at the Biotech Future Forum in 2022⁷

Case study 7:

India – delivering lifesaving medical supplies with drones



Context:

In busy cities or remote hard-to-reach areas of India, drone deliveries of medical supplies could be lifesaving. Yet, for the technology application to be rolled out, there needs to be sufficient investment, collaboration between drone companies and healthcare providers, and appropriate support and regulatory checks from government.



Action:

First, the Centre for the Fourth Industrial Revolution India worked with India's Ministry of Aviation and the state governments of Telangana and Arunachal Pradesh's to liberalize drone policy to incentivize start-up investment in drone technology. Next, the centre tested the feasibility of beyond visual line of sight drone deliveries with over 300 test flights to healthcare centres. Based on the success of the feasibility study, the centre piloted drone delivery of medical supplies to remote Himalayan regions.



Result:

25,000

beneficiaries were touched by the initiative

80%

reduction in delivery times of medical supplies was achieved

~100 lives

were indirectly saved



Next steps:

After establishing a regional milestone in medical drone deliveries, eight additional states are replicating the model. Under the AVIATE initiative on Advanced Air Mobility, India may explore heavier payload systems for both people transport and mass cargo transit. Additionally, the Medicine from the Sky initiative is poised to function independently, facilitating drone programs for governments, with preliminary discussions scheduled for this agenda.

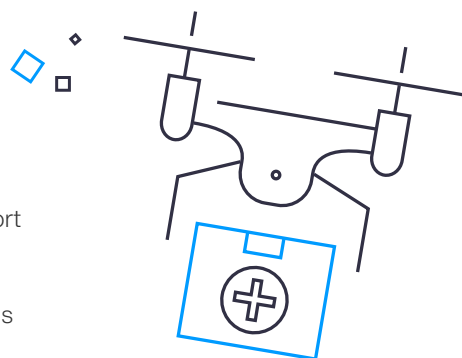

05

Supporting small businesses

Small businesses represent around 90% of businesses and more than 50% of employment worldwide. Helping small businesses to digitally transform helps future-proof a vital pillar of economies.

From raising awareness about the benefits of adopting digital technologies in small- and medium-sized enterprises (SMEs) to piloting policies aimed at accelerating adoption, several centres in the network are working to support SMEs.

The Centre for the Fourth Industrial Revolution Saudi Arabia published three awareness-raising papers to accelerate the adoption of internet of things (IoT) technologies in industrial settings, including:

- [Modernizing Small and Medium-Sized Enterprises in Saudi Arabia](#),⁸ which highlights progress in Saudi Arabia to support the digital transformation of industry.
- A guide highlighting 26 use cases of Fourth Industrial Revolution technologies in industrial settings and the benefits of adoption.

- [The 6G Technology, Connecting the Unconnected](#)⁹ white paper in collaboration with Saudi Telecom Company to explore potential 6G applications across healthcare, transport, entertainment and other industries.

The Centre for the Fourth Industrial Revolution South Africa also focused its efforts on raising awareness of the importance of SMEs to digital transformation through workshops, webinars, newsletters and case studies. They worked with partners to conduct a digital maturity assessment of small, medium and macro enterprises to identify their current level of digital readiness and their potential areas of improvement, allowing implementation partners to deploy IoT devices to monitor and improve industrial operations.

The centre in Brazil went beyond awareness raising by piloting a policy protocol in manufacturing companies to demonstrate the return on investment of adopting digital technologies [↗](#) (see case study 8).



“

From funding and talent to awareness and infrastructure, the challenges to adoption of the Fourth Industrial Revolution are great, but the efforts and initial findings from Saudi Arabia’s ongoing Fourth Industrial Revolution journey are cause not just for optimism, but for excitement. Already, industrial SMEs in the Kingdom of Saudi Arabia are using Fourth Industrial Revolution applications to increase productivity, reduce costs and enhance their competitiveness and the lessons now emerging from the Kingdom can help companies across continents to do the same.

Majed Algwaiz

General Director, Advanced Manufacturing and Innovation,
Saudi Ministry of Industry and Mineral Resources

Case study 8:

Brazil – boosting profits of small- and medium-sized manufacturing companies



Context:

Around 99% of Brazil's manufacturing industry is comprised of SMEs. Despite the promise of digital technologies to improve business operations, many SMEs face obstacles in adoption. This includes awareness of technologies and their application, a lack of capital for investment, skilled labour and know-how to improve their organizational structure and transform their business.



Action:

The Centre for the Fourth Industrial Revolution Brazil and its partners developed a policy protocol that incorporated insights from manufacturers, civil society, academics, development organizations and policy-makers to establish the needs baseline. This protocol was then tested with an initial 10 companies and verified by an additional 70.



Results:

200%

return on investment (ROI) within 4.5 months was achieved by participating companies who implemented the protocol.



Next steps:

The Brazilian Ministry of Industry will expand the framework into the “Brasil mais produtivo” programme and support the digital transformation of 200,000 SMEs by 2027, with the support of the Brazil centre.

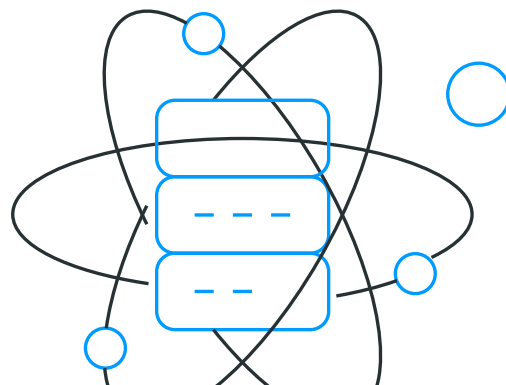

06

Protecting the environment

Increasingly, Fourth Industrial Revolution technologies are playing a pivotal role in protecting and restoring biodiversity and reducing the impact of climate change.

In Norway, the HUB Ocean thematic centre, worked with industry to enable the sharing, analysis and visualization of 10 years' worth of industrial krill data to provide a wealth of new information to scientists

for improved sustainable fisheries management. The centre also developed a tool to track CO₂ emissions from global shipping fleets [↗](#) (see case study 9).

Case study 9:

Norway – unlocking ocean data to help decarbonize the shipping industry



Context: In the contemporary corporate landscape, there is an ever-increasing demand for organizations to measure, disclose and act upon their local biodiversity and nature impact. However, fit-for-purpose data is difficult to come by.



Action:

HUB Ocean and partners developed a vessel emissions tracker and related investor tool allowing financial institutions to monitor how the companies in their portfolio impact the ocean in terms of:

- 1 CO₂ emissions from shipping
- 2 Risk to marine protected areas from shipping-related activities.



Result:

The vessel emissions tracker provides, with a 5-10% error rate, information about 300,000 ships, which is nearly the entire global shipping fleet. Companies in the financial sector use the investor tool to track the impacts and risks in their portfolios and businesses have taken action to reduce emissions and reduce risk to marine life.



Next steps:

HUB Ocean will look to scale the impact of its investor tool by expanding into other relevant ocean industries, such as fishing, aquaculture and offshore wind.

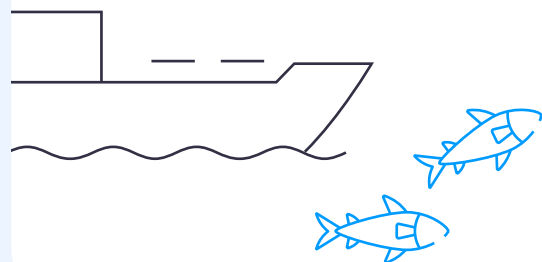



This tool will have an impact in creating transparency, which is very important in biodiversity. Lack of data is one of the greatest barriers. So, this will create impact and make it possible for stakeholders to engage with companies.

Rasmus Nørgaard
ESG Analyst at ATP, Denmark¹⁰

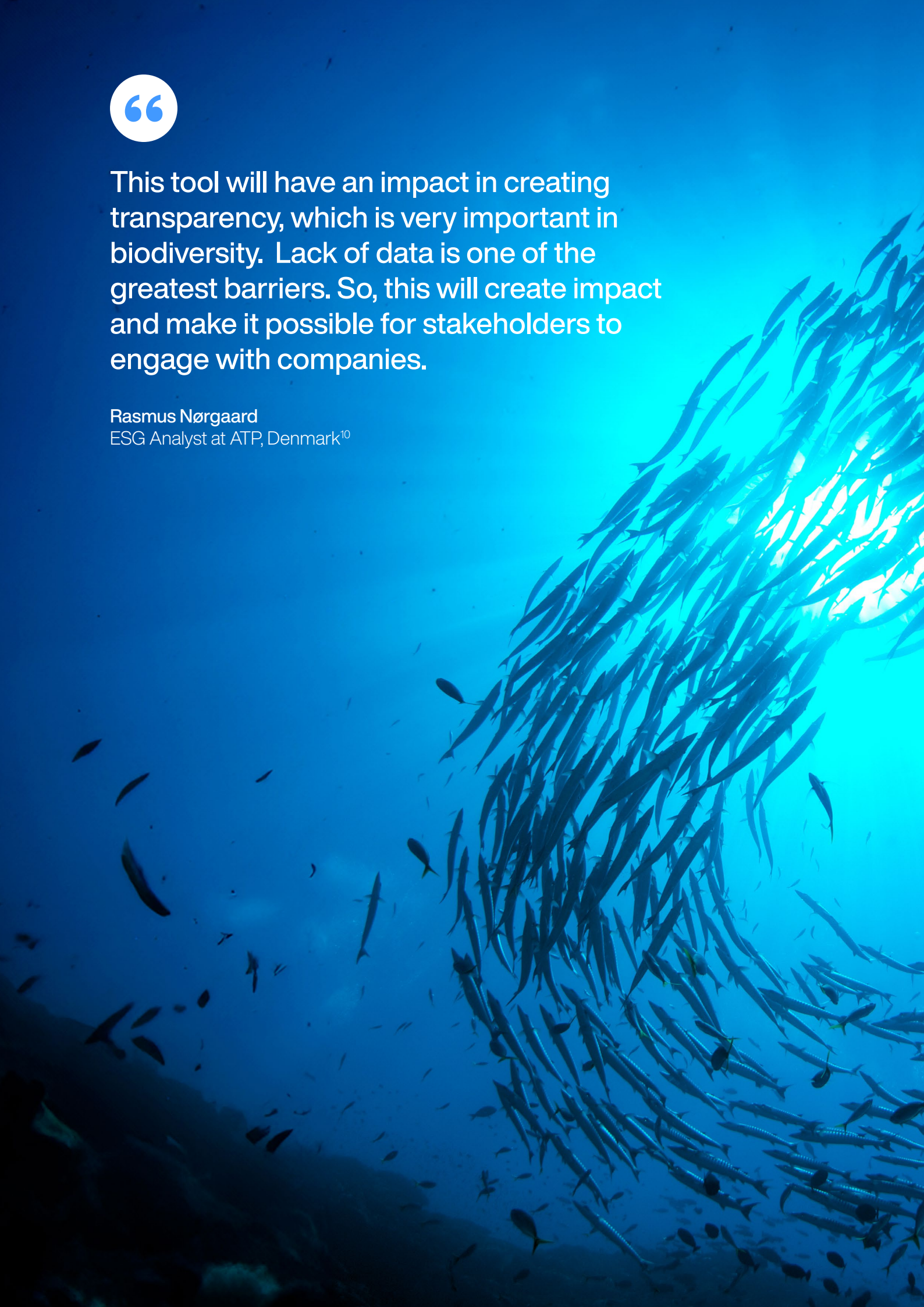

07

Educating and upskilling populations

The rapidly evolving technology landscape creates a need for technology literacy and upskilling, but at the same time, provides new approaches to education through e-learning and smart devices.

In the reporting period, the Centre for the Fourth Industrial Revolution United Arab Emirates ran the second annual “Smart Toy Awards” competition to recognize ethical and responsible smart toys to create innovative and healthy play experiences for children as they learn.

The centre in Saudi Arabia, in partnership with Saudi Telecom Company, hosted the Youth Innovators in Industry 4.0 Hackathon. This event encouraged teams of young innovators to submit creative ideas using emerging technologies. The focus was on four key sectors: tourism, education, telecom/IT and manufacturing. Five teams were awarded prizes, and their ideas were incubated for potential investment.

Moving from youth to adults, the centre based in Michigan, known as the US Center for Advanced

Manufacturing (USC4AM), helped upskill and re-skill 73 leaders across four industries from 17 states by running a series of informative “how to” webinars/workshops for various stakeholder groups including those from traditional and non-traditional manufacturing backgrounds. The centre also co-hosted a site visit and community round table event at the Apple Developer Academy.

After meeting the the Forum’s Growth Summit in Geneva, the Centre for the Fourth Industrial Revolution Azerbaijan signed a memorandum of understanding with the online platform Coursera to upskill 10,000 citizens on AI, digital transformation and blockchain, among other topics in an initiative called the Academy of the Fourth Industrial Revolution (4IR Academy).



The ‘4IR Academy’ ... contributes to the cultivation of knowledge and skills in the realm of Fourth Industrial Revolution technologies, as well as the training of proficient specialists to meet the demands of the labour market. The project promotes the development of knowledge and expertise in the field of technologies for the Fourth Industrial Revolution as well as the education of skilled professionals to fulfil the demands of the labour market.

Mikayil Jabbarov

Minister of the Economy of the Republic of Azerbaijan¹¹

08

Fostering partnerships and communities

Centre for the Fourth Industrial Revolution Azerbaijan

The centre hosted the event “AI in the Next Generation Economy: Challenges and Opportunities” to facilitate the exchange of experiences among experts in the field of AI and machine learning, with high-level speakers including the Deputy Minister of Economy in Azerbaijan.

Image: Centre for the Fourth Industrial Revolution Azerbaijan



Centre for the Fourth Industrial Revolution Brazil

Marcos Vinicius de Souza, Executive Director of the Centre for the Fourth Industrial Revolution Brazil, attended the World Investment Forum on 20 September 2023. Vinicius de Souza spoke at the “Public Procurement: Good Practices, Innovation and Control” seminar alongside Tribunal de Contas da União in partnership with Agência Brasileira de Desenvolvimento Industrial (ABDI).

Image: Centre for the Fourth Industrial Revolution Brazil



HUB Ocean

The centre gathered partners from Norway and around the globe for its 2023 Partner Event featuring presentations, workshops and discussions exploring how ocean data can address global challenges such as managing the ocean, transitioning to renewable energy, sustainable food production, green transport and sustainable investments, as well as reducing emissions and pollution.

Image: HUB Ocean



Centre for the Fourth Industrial Revolution Kazakhstan

On 4 October 2022, the International Centre for Industrial Transformation (INCIT) announced its new partnership with the Astana International Financial Center (AIFC) Tech Hub in Kazakhstan. With the signing of this memorandum of understanding, AIFC Tech Hub and INCIT worked together to support digital transformation efforts and collaboration opportunities within the country through the World Economic Forum's partner Centre for the Fourth Industrial Revolution Kazakhstan.

Image: Centre for the Fourth Industrial Revolution Kazakhstan



Centre for the Fourth Industrial Revolution Malaysia

The centre was officially launched on 15 May 2023 by the Prime Minister of Malaysia and the President of the World Economic Forum. The co-branded event at the Kuala Lumpur Convention Centre marked the beginning of the collaboration between the centre host, MYDIGITAL, and the Forum.

Image: Centre for the Fourth Industrial Revolution Malaysia



Centre for the Fourth Industrial Revolution Israel

The Israeli National Drone Initiative delegation to the UN took part in the “Flying towards the future” event hosted by the Permanent Mission of Israel to the UN on 23 June 2023. It was an opportunity to showcase breakthroughs in technology and innovation in Israel.

Image: Centre for the Fourth Industrial Revolution Israel



Centre for the Fourth Industrial Revolution Saudi Arabia

The centre co-hosted the Youth Innovators in Industry 4.0 Hackathon, where 13 teams participated with innovative solutions to unlock the potential in the Kingdom of Saudi Arabia across tourism, education, telecoms/IT and manufacturing. The centre participated as members of the jury to evaluate and select the winners of the hackathon. Winners are supported by the Saudi Telecom Company in making the minimum viable product for the most innovative ideas.

Image: Centre for the Fourth Industrial Revolution Saudi Arabia



Centre for the Fourth Industrial Revolution Serbia

The first Biotech Future Forum was hosted by the centre at the Palace of Serbia in Belgrade on 21-22 October 2022. The conference welcomed over 600 participants and speakers from 30 countries around the world, with a primary focus on the topics of biotechnology, bioinformatics and bioengineering, and emphasizing medicine and healthcare. The conference was officially opened by the Prime Minister of the Government of the Republic of Serbia, Ana Brnabić, and the President of the World Economic Forum, Børge Brende.

Image: Centre for the Fourth Industrial Revolution Serbia



Centre for the Fourth Industrial Revolution United Arab Emirates

The second annual Smart Toys Awards was hosted by the Centre in November 2022. The competition attracted 43 solutions developed by innovators, entrepreneurs, toy developers and start-ups specialized in various technology sectors from 20 countries worldwide.

Image: Centre for the Fourth Industrial Revolution United Arab Emirates



US Center for Advanced Manufacturing

The centre hosted an invitation-only launch event today at its headquarters in Detroit, Michigan, in October 2022. The day attracted leading Chief Executive Officers from across the nation in a variety of industries actively engaged in digital transformation on the factory floor, along with politicians who advocate for advanced manufacturing dominance in the US through policy change.

Image: US Center for Advanced Manufacturing



Centre for the Fourth Industrial Revolution Japan

Three official side events to the G7 ministerial meetings were hosted by the centre, including the Digital Transformation Summit in April 2023.

Image: Centre for the Fourth Industrial Revolution Japan



Meet the Fourth Industrial Revolution Centres

Centre for the Fourth Industrial Revolution Azerbaijan

Host: Center for Analysis and Coordination of the Fourth Industrial Revolution, Ministry of Economy, Government of Azerbaijan

About: The Center for Analysis and Coordination of the Fourth Industrial Revolution was established under the Ministry of Economy in accordance with the Decree of the President of the Republic of Azerbaijan dated 6 January 2021. The Center for Analysis and Coordination of the Fourth Industrial Revolution carries out cooperation between the Republic of Azerbaijan and international organizations operating in the field of the Fourth Industrial Revolution, as well as analyses and coordinates challenges, initiatives, strategies and projects related to the digital economy. The main objective of the entity is to make the most of the opportunities created by the Fourth Industrial Revolution and to ensure the leading role of Azerbaijan in the field of emerging technologies.



Launched in 2021

Partners:

Ministry of Economy of the Republic of Azerbaijan and organisations under the Ministry Export and Investment Promotion Agency of the Republic of Azerbaijan - AZPROMO

Ministry of Energy of the Republic of Azerbaijan

Ministry of Agriculture of the Republic of Azerbaijan

Ministry of Science and Education of the Republic of Azerbaijan

Ministry of Digital Development and Transport

Intellectual Property Agency of the Republic of Azerbaijan

Central Bank of Azerbaijan

The State Agency for Public Service and Social

Innovations under the President of the Republic of Azerbaijan

SOCAR

Azerbaijan Investment Holding

Azergold CSJC

Baku International Sea Trade Port

Azerbaijan Airlines

Azerbaijan International Bank

Pasha Holding

Bulutistan

StrategEast

National Informatization Agency of the Republic of Korea

MEXT Technology Center Türkiye

Digital Transformation Office of the Presidency of Türkiye

IFLYTEK

Siemens

McKinsey & Company

UNDP Baku Office

Islamic Development Bank

The German-Azerbaijani Chamber of Commerce (AHK Azerbaijan)

Azerbaijan State Economic University

Azerbaijan State Oil and Industry University

ADA University

Azerbaijan National Science Academy

Baku Higher Oil School

French Azerbaijan University

Centre for the Fourth Industrial Revolution Brazil

Host: Instituto de Pesquisas Tecnológicas (IPT)

About: IPT, Technological Research Institute, creates and applies technological solutions for sectors of the economy, governments and society to support overcoming challenges.



Launched in 2020

Partners:

Ministry of Development, Industry, Commerce and Services (MDIC)

Brazilian Agency for Industry Development (ABDI)

Secretariat of Science Technology and Innovation of São Paulo State (SCTI)

Instituto de Pesquisas Tecnológicas do Estado de São Paulo (IPT)

AstraZeneca

Bracel

Eletronbras

Meta

Qualcomm

Centre for the Fourth Industrial Revolution Colombia

Host: Ruta-N Corporation, Medellín, Colombia

About: The Centre for the Fourth Industrial Revolution Colombia aims to maximize the benefits of the Fourth Industrial Revolution for the inclusive and sustainable development of Latin America, seeking a balance between technological governance, the use of data and the adoption of emerging technologies.



Launched in 2019

Partners:

Office of the President

Ministry of Information and Communication Technologies

City of Medellín

Ruta-N Corporation

HUB OCEAN

Founder: Aker ASA

About: Aker ASA (Aker) is an industrial investment company with ownership interests concentrated within the sectors of oil and gas, renewable energy and green technologies, industrial software, seafood, and marine biotechnology. Aker ASA exercises active ownership to create values, combining industrial expertise with financial strength and capital market expertise. Through board positions, it helps to develop and strengthen each portfolio company by driving strategy developments, operational improvements, financing, restructurings and transactions.



Launched in 2020

Partners:

Including, but not limited to:

Accenture

The Aker Group: Aker BP, Aker BioMarine, Aker Solution, Aker Horizon

Aramco

BAHR

Blue Cloud Consortium

Cognite

Fugro

The High-Level Panel for a Sustainable Ocean Economy

Illiad - Digital Twins of the Ocean

I-K-M

IOC-Unesco Ocean Decade

Microsoft

Mercuria

Mærsk Mc-Kinney Møller Center for Zero Carbon Shipping (MMMCZCS)

The North Alliance (NoA)

NHO

OPS Sjømat

Sintef Ocean

Centre for the Fourth Industrial Revolution India

Host: World Economic Forum



Launched in 2018

Partners:

3M

Adani Group

Agnext

Algorand Foundation

Andhra Pradesh

Arthur D Little

Arunachal Pradesh

Asian Development Bank

Axis Bank

Bajaj Finance

Bharat Innovation Fund

Bill & Melinda Gates Foundation

Byjus

CEEW

CII

Coinswitch

Dabur

Flipkart

GMR

Government of Karnataka

Government of Madhya Pradesh

Government of Maharashtra

Government of UP

Greenko

HCL Technologies

HDFC Bank

HealthNet Global (Apollo)

Heritage Foods

IFFCO

Infosys

iSPIRT

Jetsetgo

Jubilant Bhartia

Mahindra Group

MARS

Mastercard

Meghalaya government

Microsoft

Ministry of Agriculture

Ministry of Civil Aviation of India (MoCA)

Ministry of Electronics and Information Technology (MeitY)

Ministry of Finance

Ministry of Fisheries

Ministry of Health

Ministry of Heavy Industries

Ministry of Law and Justice

Ministry of Science and Technology

NABARD

Nestlé

Ninjacart

NITI Aayog (National Institution for Transforming India)

NIUA

NTPC

PSA

PwC

Qualcomm

Reliance Industries Limited (RIL)

Saahas Zero Waste

Centre for the Fourth Industrial Revolution Israel

Host: Israel Innovation Authority

About: Responsible for the country's innovation policy, the Israel Innovation Authority provides Israeli companies and entrepreneurs with a variety of practical tools and funding platforms aimed at addressing the dynamic and changing needs of the local and international innovation ecosystems. It provides conditional grants to support disruptive technological innovations and prepare for future technologies in order to maintain both technological and economical leadership as well as improve productivity and global competitiveness of the Israeli economy. Its initiatives span a wide range of industries, from cutting-edge technology to sustainable innovation, positioning Israel as a global hub for groundbreaking ideas and transformative solutions.



Launched in 2019

Partners:

International Division, Israel Innovation Authority

Various divisions in the Israel Innovation Authority

The Civil Aviation Authority of Israel (CAAI)

The Ministry of Transportation

The Ministry of Health

The Ministry of Finance

The Ministry of Economy

Prime Minister's Office

Ministry of Justice

GFI Israel

Ayalon Highways

Health IL

Haifa University

Health sector: 18 public and private hospitals all over Israel and health maintenance organizations (HMOs).

National emergency entities: Israeli police, Magen David Adom.

Centre for the Fourth Industrial Revolution India

Centre for the Fourth Industrial Revolution Japan

Host: World Economic Forum



Launched in 2018

Partners:

AISIN

DENSO

Eisai

Hitachi

HORIBA

McKinsey Japan

Mitsubishi Chemical Holdings

MORI Building

NEC

Nippon Telegraph and Telephone (NTT)

Salesforce Japan

SOMPO Holdings

Suntory Holdings

Takeda Pharmaceutical

Toyota

Centre for the Fourth Industrial Revolution Kazakhstan

Host: Astana International Financial Center (AIFC) Tech Hub

Host boilerplate: The AIFC Tech Hub is a meeting point for global start-ups, entrepreneurs, investors, the industry's top experts and a great talent pool. It helps develop a more diverse and knowledgeable fintech space in Kazakhstan and the region with a pipeline of opportunities for venture capital funds and financial institutions.



Launched in 2021

Partners:

Ministry of Digital Development, Innovations and Aerospace Industry

Ministry of Energy

Department of Industry Development

Department of Digital Transformation

Digital Techno Park Astana Hub

National Managing Holding Baiterek,

Qazaqstan Investment Corporation

Kazpost Digital

Republican Center for Space Communications

International Centre for Industrial Transformation
(INCIT)

Centre for the Fourth Industrial Revolution Malaysia

Host: MyDIGITAL Corporation

Host boilerplate: MyDIGITAL Corporation was incorporated in September 2021 as a Strategic Change Management Office to lead national-level change management in driving the execution of the initiatives under the Malaysia Digital Economy Blueprint and the National Fourth Industrial Revolution Policy.



Launched in 2023

Partners:

Access Partnership

Bursa Malaysia

Microsoft Malaysia

Ministry of Communications and Digital

Ministry of Economy

Ministry of Finance

Ministry of International Trade & Industry

Ministry of Natural Resources, Environment and

Climate Change

Ministry of Science, Technology and Innovation

World Bank

Centre for the Fourth Industrial Revolution Rwanda

Host: Ministry of Information Communication Technology and Innovation

Host boilerplate: The Ministry of Information Communication Technology and Innovation has a mission of addressing national priorities for economic growth and poverty reduction through development and coordination of national information technology, communication and innovation policies and programmes as well as citizen's empowerment.



Launched in 2020

Partners:

Bill & Melinda Gates Foundation

Data Protection Office

Digital Umuganda

GIZ (German Corporation for International Cooperation)

Rwanda Biomedical Centre (RBC)

Centre for the Fourth Industrial Revolution Saudi Arabia

Host: King Abdulaziz City for Science and Technology (KACST)

Host boilerplate: King Abdulaziz City for Science and Technology, established in 1977, serves as Saudi Arabia's primary scientific R&D institution and national laboratory. KACST, established in 1977, is Saudi Arabia's premier national laboratory and science technology park, playing a critical role in enhancing the nation's economic competitiveness and societal well-being. Its vision is to enlighten both Saudi Arabia and the world through innovations in science and technology. An important aspect of this vision is the Science and Technology Park, designed to be a business hub that facilitates the commercialization of knowledge and innovation, connecting businesses and start-ups in the fields of science and technology, driving value creation and fostering a vibrant ecosystem of innovation and entrepreneurship.



Partners:

- Ministry of Economy and Planning (MEP)
- ARAMCO
- Mohammed Bin Salman Nonprofit City (MISK)
- BCG
- Ministry of Communications and Information Technology (MCIT)
- STC
- Unmanned Vehicles Technology Association
- Deloitte
- Ministry of Industry and Mineral Resources (MIM)
- NEOM
- G20 Global Smart Cities Alliance (GSCA)
- Ministry of Environment, Water and Agriculture (MEWA)
- YOKOGAWA
- Ministry of Municipal Rural Affairs and Housing (MOMRAH)
- Alrouf
- Ministry of Transport and Logistic Services (MoTL)
- AlKuhaimi Metal Industries
- National Industrial Development and Logistics Program (NIDLDP)
- Group Five Pipe Saudi

- Saudi Authority for Data and Artificial Intelligence (SDAIA)
- ALLAMAA
- Saudi Industrial Development Fund (SIDF)
- Riyadh Steel
- Public Investment Fund (PIF)
- CNTXT
- Environmental Fund
- EGIC
- Agricultural Development Fund
- International Centre for Industrial Transformation (INCIT)
- Royal Commission for Riyadh City (RCRC)
- CEER
- Royal Commission For AIUla (RCU)
- Taibah Valley
- Madinah Development Authority
- Thynkli
- General Authority of Civil Aviation (GACA)
- Volocopter
- General Authority for Military Industries (GAMI)
- Sharq Aerospace
- Saudi Post (SPL)
- Dronamics
- Monsha`at
- Microsoft
- MODON
- National Technology Services for Trade & Supply (NTSTS)
- Transport General Authority (TGA)
- Saudi Agricultural and Livestock Investment Company (SALIC)
- Saudi Air Navigation Service (SANS)
- Saudi Investment Recycling Company (SIRC)
- Digital Government Authority (DGA)
- Sharqia Development Authority
- Saudi Federation for Cyber Security and Programming (SAFCSP)
- Saudi Standards, Metrology and Quality Organization
- General Authority for Survey and Geospatial Information
- National Center for Palms and Dates (NCPD)
- AlAhsa Center for Palms and Dates
- Weqaa Center

Centre for the Fourth Industrial Revolution Serbia

Host: Government Office for IT and eGovernment

Host boilerplate: The Office for IT and eGovernment of the Government of the Republic of Serbia is dedicated to overseeing the overall digitalization efforts in Serbia, emphasizing the digitization of healthcare. Additionally, it is responsible for managing the state infrastructure to ensure secure data storage for its citizens.



Launched in 2022

Partners:

Amazon Web Services (AWS)

BGI Group

BIO4 Campus

Biology (BIRBI)

British Embassy in Serbia

Clinical Centre of Serbia (UKCS)

Coordination Body for the Digitalization of Health

Embassy of Canada to Serbia

EMBL-EBI

Engineering (IMGGE)

Faculty of Biology in Belgrade

GA4GH

Innovation

Institute for AI Research and Development (IVI)

Institute of Molecular Genetics and Genetic

Institute of Oncology and Radiology (IORS)

Ministry of Health

Ministry of Information and Telecommunications

Ministry of Science, Technological Development and Innovation

National Alliance for Local Economic Development (NALED)

National Organization for Rare Diseases of Serbia (NORBS)

Office of the Prime Minister

Patients Association of Serbia

Roche

Serbian Society for Bioinformatics and Computational

Takeda

United Nations Development Programme (UNDP)

Velsera

Centre for the Fourth Industrial Revolution South Africa

Host: Council for Scientific and Industrial Research (CSIR)

Host boilerplate: The collaboration among the Centre for the Fourth Industrial Revolution South Africa, CSIR and the Department of Science and Innovation is dedicated to driving responsible adoption and deployment of emerging technologies, empowering innovation, research and socioeconomic development in South Africa while creating an environment conducive to inclusive and sustainable technological advancement for the benefit of industry and society.



Active: 2019-2023

Partners:

Automotive Industry Development Centre Eastern Cape

City of eThekweni

City of Johannesburg

City of Tshwane

Department of Communications and Digital Technologies

Department of Cooperative Governance and Traditional Affairs

Department of Public Service and Administration

Department of Science and Innovation

Department of Trade, Industry and Competition

Deutsche Gesellschaft für Internationale Zusammenarbeit

Eastern Cape Socio-Economic Consultative Council

Erith Technologies

Foreign, Commonwealth & Development Office

Jendamark Automation

Kagiso Trust

Siemens Energy

South African Cities Network

South African Institute of Chartered Accountant

South African Local Government Association

Western Cape Government

Centre for the Fourth Industrial Revolution Telangana

Host: Telangana Lifesciences Foundation

Host boilerplate: Telangana Life Sciences, part of the state government of Telangana, seeks to become the leading life sciences hub in Asia through innovation-driven and tech-enabled growth, while doubling the sectoral value to \$100 billion and adding 400,000 new jobs by 2030.



Launched in 2023

Partners:

Bristol Myers Squibb

Granules

Medtronic

MSN

Reddy's

Roche

Digital Medicine Society (DiMe)

Northeastern University

Novartis

Centre for Trustworthy Technology

Host: Patrick J. McGovern Foundation

Host boilerplate: A global, 21st-century philanthropy, the Patrick J. McGovern Foundation is committed to bridging the frontiers of AI, data science and social impact.



Launched in 2023

Partners:

Deloitte

Centre for the Fourth Industrial Revolution Turkiye

Host: Turkish Employers Association of Metal Industries (MESS)

Host boilerplate: MESS was established in İstanbul in 1959 by 11 visionary and modern entrepreneurs who committed themselves to the industrialization of the country. To accelerate digital and green transformation of the Turkish industry, MESS established MEXT Technology Center in 2020. Nestled within its cutting-edge 10,000-square-meter facility, MEXT is equipped with a state-of-the-art digital factory, training facilities, office spaces, a vibrant co-working area and a dynamic conference centre. MEXT offers an array of transformative services designed to pave the way for a more inclusive, sustainable and digital future.



Active: 2020-2023

Partners:

BCG

INC Invention Center

İstanbul Bilgi University (Türkiye)

King Abdulaziz City for Science and Technology (KACST)

Koç University (Türkiye)

INC Innovation Center

MaestroHub

McKinsey

Microsoft

Türkiye Ministry of Industry and Technology

TüvSüd

United Arab Emirates Ministry of Industry and Advanced Technology

Centre for the Fourth Industrial Revolution United Arab Emirates

Host: Dubai Future Foundation

Host boilerplate: The Dubai Future Foundation builds a cohesive innovation ecosystem that includes accelerator programmes, incubators, labs, regulatory sandboxes and knowledge platforms – all to challenge the status quo and design a future-ready city powered by future leaders and disrupters.

 **Launched in 2019**

 **Partners:**

- Abu Dhabi Early Childhood Authority
- Consumers International
- DeepOpinion
- KidsRights Foundation
- United Arab Emirates Gender Balance Council
- United Arab Emirates National Programme for Coders
- UNICEF Gulf Area Office

US Centre for Advanced Manufacturing

Host: Automation Alley

Host boilerplate: Automation Alley is a non-profit technology business association and Digital Transformation Insight Center focused on driving the growth and success of businesses in Michigan and beyond through innovation and automation. With a global outlook and a regional focus, it creates a vibrant community of innovators, entrepreneurs and business leaders through opportunities for collaboration and learning. Its programmes and services help businesses develop the skills and expertise needed to effectively jumpstart or accelerate digital transformation. By bringing together industry, academia and government, the centre aims to create a dynamic ecosystem that drives innovation and growth across Michigan.

 **Launched in 2022**

 **Partners:**

- Accenture
- Association of Manufacturing Technology Online
- Automation Alley
- Divergent Technologies
- Everstream Analytics
- Fanuc
- GE Healthcare
- International Trade Association
- MEDC
- Schneider Electric
- Tulip
- Western Digital

Contributors

Lead authors

Greta Keenan

Lead, Strategic Impact and Communications,
Centre for the Fourth Industrial Revolution,
World Economic Forum

Alicia Patterson-Waites

Specialist, Strategic Impact,
Centre for the Fourth Industrial Revolution,
World Economic Forum

Acknowledgements

Sebastian Buckup

Head, Network and Partnerships,
World Economic Forum

Mario Canazza

Engagement Lead, Americas, World Economic Forum

Valeria D'Amico

Specialist, Network and Government Affairs,
World Economic Forum

Suzi Gao

Specialist, Impact Monitoring and Evaluation
World Economic Forum

Manju George

Head, Strategic Impact and Integration,
World Economic Forum

Aytug Goksu

Head, Network and Government Affairs,
World Economic Forum

Rebecca King

Lead, Strategic Integration, World Economic Forum

Vandana Menon

Engagement Lead, Asia, World Economic Forum

Priya Vithani

Engagement Lead, Middle East and North Africa,
World Economic Forum

Additional thanks go to **centres in the Centre for the Fourth Industrial Revolution Network** for participating in a reporting exercise to measure impact between Q4 2022 and Q3 2023.

Production

Laurence Denmark

Creative Director, Studio Miko

Martha Howlett

Editor, Studio Miko

Oliver Turner

Designer, Studio Miko

Collaborators

The World Economic Forum would like to thank the Business Partners and Innovators of the Centre for the Fourth Industrial Revolution for their engagement with the Network and collaboration on global technology initiatives.

Absa Group
Abu Dhabi National Oil Company (ADNOC)
Accenture
Activefence Ltd. (515838092)
Adecco Group AG
Adobe Inc.
AI21 Labs Ltd.
AIG
Airport Authority (Hong Kong)
Aker ASA
Al Futtaim Private Company LLC
Alibaba Group
AlixPartners
All-In Technology
Alphabet
Amazon
América Movil SAB de CV
American Tower Corporation
AMTD Group
Animoca Brands LTD
Antin Infrastructure Partners SAS
Aporia Technologies
Asimov
Astra
Astranis Space Technologies Corp
AstraZeneca Plc
Astroscale Holdings Inc.
Authing
Avanci
Axiom Space, Inc.
Azerbaijan Government
Bahrain Economic Development Board
Bain & Company Inc.
Bajaj Holdings & Investment Limited
Banco Bradesco SA
Barclays Bank Plc
BBVA SA
Beenova AI
Beijing Langboat Technology

BEIT
Bharti Airtel Limited
BlackRock Inc.
Bloomberg LP
Booming Tech
BorgWarner Inc.
Boston Consulting Group
Bota Biosciences
Bracell Celulose Solúvel Especial Participações LTDA
Brazilian Agency for Industrial Development (ABDI)
Burda GmbH
Bytedance Ltd.
C3 AI
Cadence Design Systems Inc.
Canica Holding AG
Capgemini SE
Center for Technology Integrity, Inc. a Centre for the Fourth Industrial Revolution
Centrais Elétricas Brasileiras SA - Eletrobras
Centrly
Charoen Pokphand Group Company Limited (CP Group)
Cisco Systems, Inc.
Citi
Citibears
CITIC Group Corporation
Clariant International Ltd
ClimateAI
Cognizant Technology Solutions US Corp.
Cohere Inc.
COL Group Co., Ltd
Colossal Biosciences
Condé Nast
Contents Technologies
Credit Suisse AG
Credo AI
Crescent Enterprises
Crisp Thinking Group Limited
Crowd AI
Crusoe
Cujo LLC
Cyacomb
DAMAC International Limited
Daniel J. Edelman, Inc
DataStax Inc

Dawex
Deepen AI, Inc.
DeepLearning.AI, LLC
Dell Technologies
Deloitte
Dentsu Group Inc.
Deutsche Bank AG
Dogan Şirketler Grubu Holding A.S
Dot
Dove Air
Dow Jones & Company Inc.
DP World Limited
Dubai Electricity and Water Authority (DEWA)
Dubai Future Foundation
e&
Edenred SE
Emerge
Emirates NBD
EnginZyme
Euroclear SA/NV
EY
Ezaki Glico Co., Ltd.
Floreo
Frontera Energy
FTI Consulting Inc.
Fujitsu Limited
Gartner Inc.
General Atlantic Service Company, L.P.
GEP
GHGSat Inc.
Gloat Ltd
GLOBIS Corporation
Google Inc.
Grab
Grammarly, Inc
Grupo Salinas
Gunvor SA
Hacı Ömer Sabancı Holding A.Ş.
Haier Group
Hanwha Solutions Corporation
HawkEye 360 Inc.
HCLTech
HD Hyundai Co. Ltd
Heidrick & Struggles
Helsing GmbH
Hewlett Packard Enterprise
High Fidelity
Hisense Group Holdings Co., Ltd.
Hitachi Ltd
Honda Motor Co., Ltd
Horizon Blockchain Games
HP Inc.
HTC-VIA
Huawei Technologies Co. Ltd
IBM Corporation
Ifood.Com Agencia de Restaurantes Online S.A
Ignite
Ihlas Holding SA
Indian Oil Corporation Ltd
Inflection AI, Inc.
Inflection
Infostellar
Inner Mongolia Mengniu Dairy (Group) Co. Ltd
Innovusion
INOX Group
Insitro Inc
Intel Corporation
International Finance Corporation (IFC)
Intesa Sanpaolo SpA
IQM Finland Oy
IQVIA
Iron Mountain Information Management LLC
Isar Aerospace Technologies GmbH
ispace, inc
Israel Innovation Authority
Jahez International Co
JERA Co., Inc.
JLL
JPMorgan Chase & Co.
Kaiser Foundation Health Plan Inc.
Kayrros SAS
King Abdulaziz City for Science and Technology (KACST)
Koç Holding AS
KONUX Inc.
Kudelski Group
L'Oréal
Lenovo Group
LGT Group Foundation
Liberty Global Corporate B.V.
Lippo Group
Lloyds Banking Group Plc
London Stock Exchange Group plc

Lulu Financial Group
 Lulu Group International LLC
 Lynx
 Maekyung Media Group
 Mahindra Group
 Majid Al Futtaim Management Services LLC
 Manchester United Football Club Limited
 ManpowerGroup Inc.
 Manulife Financial
 Mastercard International Incorporated
 Medtronic Plc
 Meta Platforms Inc.
 METAPHYSIC LIMITED
 Microsoft Corp.
 Mission Space
 Mitsubishi Electric Corporation
 Mitsubishi Heavy Industries, Ltd.
 MKS PAMP SA
 Mohammed Bin Salman Foundation (MiSK)
 Motovis Intelligent Technologies
 Motsepe Foundation
 MTR Corporation Limited
 Mubadala Investment Company
 MUFG Bank Ltd
 MultiChoice Group Ltd
 MyDigital Corporation, Ministry of Economy
 Naspers Limited
 NBCUniversal Media, LLC
 NEC Corporation
 NEOM Company
 Netguru S.A.
 Neusoft Corporation
 NextBillion.ai
 Nielsen
 Nikkei Inc.
 Novo Nordisk Foundation
 OC Oerlikon
 Octant, Inc.
 Office for Information Technologies and e-Government
 of Serbia
 Old Mutual Emerging Markets Limited
 OmniBot GmbH
 Omnicom Group
 OpenAI OpCo, LLC
 Orbit Fab
 Owkin Inc
 Oxford Quantum Circuits
 Palantir Technologies Inc.
 Palo Alto Networks
 Panasonic Connect Co., Ltd.
 PandoCorp
 Pano AI
 Papercup
 PASQAL
 Pathfinder Group
 PayPal
 Pegasystems Inc.
 Photonic Inc.
 PINTEREST, INC.
 Pix Moving
 PPF A.S.
 PricewaterhouseCoopers LLP
 Private AI
 Procter & Gamble
 Pryon Inc
 PT Bank Rakyat Indonesia (BRI)
 PT Elang Mahkota Teknologi (Emtek)
 Publicis Groupe SA
 Pymetrics Inc.
 Q-CTRL Pty Ltd
 Qatar Investment Authority
 QCraft
 Qualcomm Incorporated
 Qualcomm Serviços de Telecomunicações Ltda (Brazil)
 Randon S/A Implementos e Participações
 Recruit Holdings Co. Ltd
 Reejig
 Regrow Agriculture Inc.
 Reliance Industries Limited
 Reliance Industries Limited
 Resolution Games
 RGE Pte Ltd
 Robert Bosch GmbH
 Royal Philips
 Rwanda Government
 S4Capital plc
 Salesforce, Sàrl
 Samsung Electronics Co. Ltd
 SandboxAQ
 SAP SE
 Saudi Aramco
 Saudi Telecom Company (STC)
 Scale AI

Schneider Electric SE
Scopely, Inc.
Sekunjalo Investment Holdings
Sendbird
Seoul Robotics
Sequoia Capital Operations LLC
ServiceNow, Inc.
ShintaVR
SICPA Holding SA
Siemens AG
Silver Lake Technology Management LLC
SingleStore
SK Inc.
Slang App
SM Investments Corporation
Smardaten Technologies
Société Générale
Somnium Space
Sompo Holdings Inc.
Sony Group Corporation
Space Perspective
SpeQtral Pte Ltd
Splunk Inc.
Strangeworks, Inc.
SWIFT SC
SYKY
Synthesia
Takeda Pharmaceutical Company Limited
Tata Consultancy Services Ltd
Tata Sons Pvt Ltd
TCL Technology Group Corporation
TD Bank Group
Teck Resources Limited
Telefonaktiebolaget LM Ericsson
Telefonica SA
Telenor Group
Teleperformance
The Coca-Cola Company
The Depository Trust and Clearing Corporation (DTCC)
The Exploration Company GmbH
The New York Times
The Olayan Group
The Standard Bank Group Limited
Think and Learn Private Limited
TIER IV
Tillman Global Holdings LLC

TIME
TIRPORT
TOPPAN HOLDINGS INC.
Trip.com Group Ltd
Truepic
TSB Gaming Limited
TTTech Auto AG
Türkiye'nin Otomobili Girişim Grubu A.Ş. (TOGG)
TVS Group
Twelve Labs Inc.
Twin Science
Two Sigma Investments, LP
Uber Technologies Inc.
UBS AG
Unilever
Uniphore Software Systems Inc.
Unison Capital Inc.
Unitel SA
UPL Ltd
Vahan Technologies
Vattenfall AB
Verizon Communications
Versatile
ViaSat
Vindex LLC
Visa Inc.
Vista Equity Partners
Volvo Car Corporation
Voyager Space
VRdirect GmbH
Weights and Biases, Inc.
Western Digital Corp.
Wingcopter GmbH
Wipro Limited
Wiz
Wolfprint 3D
Workday Inc.
Writer, Inc.
Yara International ASA
YI TUNNEL (BEIJING) TECHNOLOGY CO LTD
Yoti Ltd
Zenith Bank Plc
Zeroavia
Zoom Video Communications, Inc.
Zurich Insurance Company LTD

Endnotes

1. Ng, Jing Ting, Haridas, Teoh, "The Economic Impact of Generative AI: The future of work in Malaysia", September 2023. <https://accesspartnership.com/the-economic-impact-of-generative-ai-the-future-of-work-in-malaysia/>
2. MyDigital, *GenAI Report Launch* [Press release], 15 September 2023, <https://www.mydigital.gov.my/genai-report-launch/>
3. "Rwanda's AI strategy: From vision to reality", *World Economic Forum*, 31 March 2022, <https://www.weforum.org/impact/data-access-to-healthcare-in-rwanda/>.
4. World Economic Forum, *Four Years of the Centre for the Fourth Industrial Revolution India*, 2023, https://www3.weforum.org/docs/WEF_Four_Years_of_the_Centre_for_the_Fourth_Industrial_Revolution_India_2023.pdf.
5. Akin Armutak, Fendri, "https://www3.weforum.org/docs/WEF_AI_in_Manufacturing_2022.pdf", December 2022. https://www3.weforum.org/docs/WEF_AI_in_Manufacturing_2022.pdf.
6. World Economic Forum, *AI Can Enable a New Era in Manufacturing Sector, Says World Economic Forum White Paper* [Press release], 12 December 2022. <https://www.weforum.org/press/2022/12/ai-can-enable-a-new-era-in-manufacturing-sector-says-world-economic-forum-white-paper/>.
7. "Centre for the Fourth Industrial Revolution Serbia Launched at Biotech Future Fom in Belgrade", *The Office for Informatino Technologies and eGovernment*, 20 October 2022, <https://www.ite.gov.rs/vest/en/809/centre-for-the-fourth-industrial-revolution-serbia-launched-at-biotech-future-forum-in-belgrade.php>.
8. Alaskar, Algwaiz, AlShunaifi, "Modernizing Small and Medium-Sized Enterprises in Saudi Arabia", June 2023. https://www3.weforum.org/docs/WEF_Modernizing_Small_Medium_Sized_Enterprises_in_Saudi_Arabia_2023.pdf.
9. Alsadun, Ahmed, Mohammed, Jameel, "6G Technology - Connecting the un-connected", September 2023. https://c4ir.sa/docs/6G_Technology.pdf.
10. Jespersen, Kristjan, "Investors are blind to sustainability when they invest in shipping", *Copenhagen Business School*, 16 December 2022, <https://www.cbs.dk/pressen/nyheder/investorerne-blinde-forhold-baeredygtighed-naar-investerer-shipping>.
11. Jabbarov, Mikayil, "The Center for Analysis and Coordination of the Fourth Industrial Revolution", X, 30 August 2023, <https://twitter.com/mikayiljabbarov/status/1696779770782969927?s=48&t=Lf9QCraUP46DqMESmGuX2w>.

Centre for the
Fourth Industrial
Revolution

✉ C4IRnetwork@weforum.org

🌐 initiatives.weforum.org/c4ir/home